

**Get an Estimate...** Once you have your complete countertop information recorded in the Design Grid Page, you are ready to get estimates. With the information you have, it should take no more than 5 minutes to get a quote online from [depotestimator.com](http://depotestimator.com). You will receive an instant quote and your project estimate can be stored as a "Saved Project" on [depotestimator.com](http://depotestimator.com), which you can review or modify to create the perfect combination of color and edge profile for your budget. When you have the right project for your home, you can print your estimate and bring it to Home Depot to make your purchase.

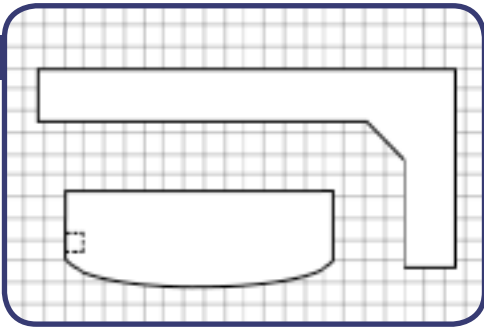

### Step 1: Layout

Begin by selecting the pieces that will compose your countertop project. Most commonly occurring pieces can be selected by clicking on the various tabs in Step 1. If you cannot find the exact piece you need, you will probably be able to achieve the piece by combining two or more pieces. Keep in mind that pieces are not to-scale and you will be able to move and modify pieces in the Design Grid to achieve your kitchen layout, however the location and proportion of pieces in the Design Grid does not factor into your estimate.

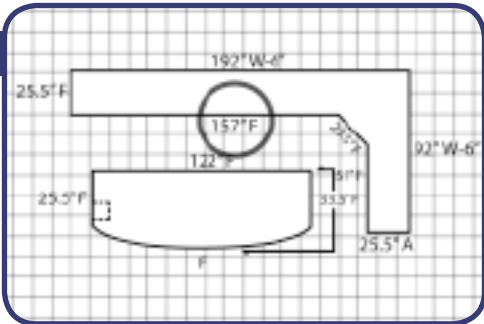
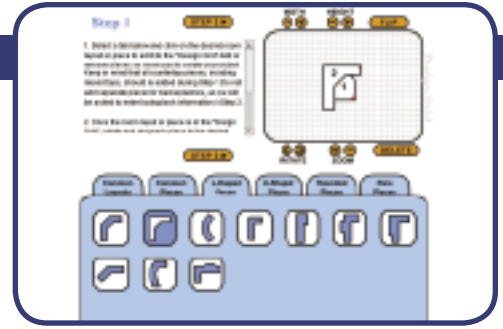

### Step 2A: Measurements

Begin Step 2 by entering each dimension of the piece selected. You may find it helpful to rotate the drawing you have in the Design Grid Page to match the diagram on the screen. Enter dimensions in inches. You may indicate dimensions of fractions of inches by using decimals, (ex. 1/2" will be entered as .5) rounding up/down to the nearest second decimal place.

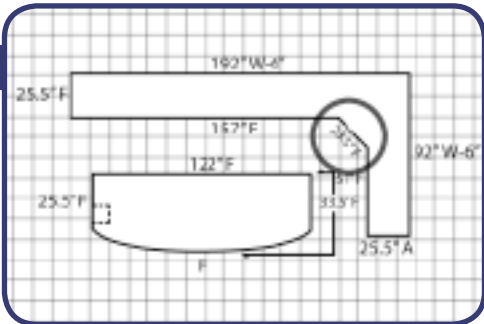
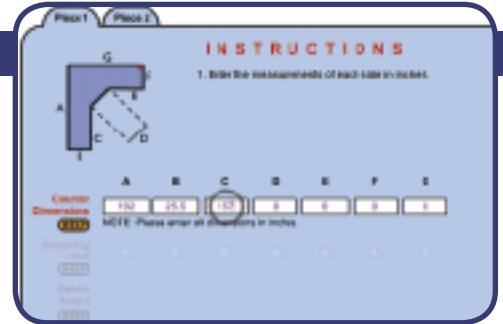

### Step 2B: Borders

Next, input the border information for each side of each piece by checking either: Bordering Wall, Bordering Appliance, or Finished Edge below the dimensions. (You will only be able to select one border for each side, and you will not be able to move on until each side has a border specified.) If a side bordering a wall has a backsplash, indicate the height of the backsplash by entering the dimension in inches in the Splash Height box for that side. For walls without a backsplash, simply disregard this box and leave the splash height as 0.

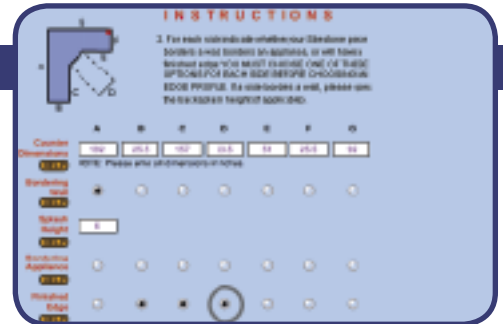

### Step 2C: Edge Profile & Color

### Step 3: Options

### Step 4: Save/Print

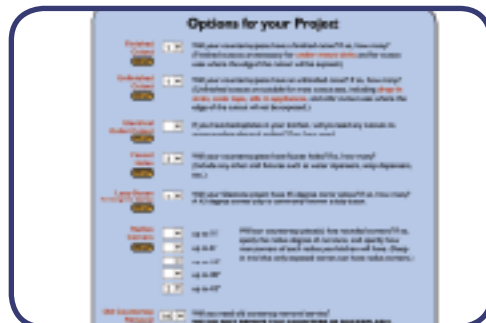

When you have finished entering your measurements and border information, you will be asked to choose your edge profile and color. Do this by selecting one of the options from the provided drop-down menus. Piece details and price shown next to the color are for the piece you are working on only. (Feel free to change the color and edge to see what the price difference will be.) Once you have finished the selected piece, go on to the next piece. When you have completed all pieces (i.e. entered all dimensions and borders, and selected edge and color), you will be able to move on to Step 3.

Now that Step 2 is finished, choose the options you want for your project. Complete this step by simply selecting the quantity of each option you need from the drop-down menu provided. Leave the drop-down menus empty for options that are not required for your project.

Step 4 displays your order summary details and allows you to save or print your project. Saved Projects can be accessed from virtually anywhere at any time, allowing you to review and/or modify your project estimate at your convenience. When you are ready to proceed with your project, simply print your project estimate and bring it to a local Home Depot.